



## HQC Series

Instrumentation Quick Couplings



quick couplings



CRANE Instrumentation & Sampling, HOKE®  
PO Box 4866 • Spartanburg, SC 29305-4866  
(864) 574-7966 • [www.hoke.com](http://www.hoke.com)

## **For Your Safety**

---

It is solely the responsibility of the system designer and user to select products suitable for their specific application requirements and to ensure proper installation, operation, and maintenance of these products. When selecting products, the total system design must be considered to ensure safe, trouble-free performance. Material compatibility, product ratings and application details should be considered in the selection. Improper selection or use of products described herein can cause personal injury or property damage.

Contact your authorized HOKE® sales and service representative for information about additional sizes and special alloys.

## **SAFETY WARNING:**

---

HOKE® products are designed for installation only by professional suitably qualified licensed system installers experienced in the applications and environments for which the products are intended. These products are intended for integration into a system. Where these products are to be used with flammable or hazardous media, precautions must be taken by the system designer and installer to ensure the safety of persons and property. Flammable or hazardous media pose risks associated with fire or explosion, as well as burning, poisoning or other injury or death to persons and/or destruction of property. The system designer and installer must provide for the capture and control of such substances from any vents in the product(s). The system installer must not permit any leakage or uncontrolled escape of hazardous or flammable substances. The system operator must be trained to follow appropriate precautions and must inspect and maintain the system and its components including the product(s) and at regular intervals in accordance with timescales recommended by the supplier to prevent unacceptable wear or failure.



# HQC Series

Instrumentation Quick Couplings



### Typical Applications

- Laboratories
- University labs
- Gas distribution
- Biopharmaceutical

### Technical Data

<b>CONSTRUCTION</b>	316 Stainless steel*
<b>NOMINAL FLOW SIZES</b>	1/4", 3/8", 1/2"
<b>MAXIMUM OPERATING TEMPERATURE</b>	3600 psi
<b>C<sub>v</sub> FACTORS</b>	.31 - 1.86

\* Other Alloys available - consult factory.

### Features & Benefits

- Leak tight sealing is achieved through multiple o-ring seals located in the couplers. Viton® is standard.
- Poppet valves with dependable, integral o-ring seals are standard in coupler and plug in double-end-shutoff applications. In single-end-shutoff applications the poppet valve is installed in the body half.
- Valve guides align valves exactly to the coupler's valve seat preventing chance of leakage when in a disconnected mode.
- Locking mechanisms in bodies provide smooth positive sleeve engagement. A firm grip of the plug portion of the coupling assembly is assured with HOKE's Xylan®-coated stainless locking tabs.
- 316 stainless steel springs
- GYROLOK® nut and ferrule system provides leak-tight end connection.
- Keyed sleeves for all sizes
- HOKE® HQC Series quick couplers are interchangeable with Swagelok® and Parker®.
- Special High Tolerance NPT Thread

quick couplings

# HQC Series Instrumentation Quick Couplings

## Rated Working Pressure (psi)

BODY SIZE	STAINLESS STEEL PRODUCTS		
	1/4"	3/8"	1/2"
CONNECTED POSITION	3600	1500	750
DISCONNECTED POSITION	3600	1500	750
CONNECT UNDER PRESSURE	250	250	250

## Spillage/Air Inclusion

	AIR INCLUSION	SPILLAGE
	HQC4	0.3 cm <sup>3</sup>
HQC6	1.0 cm <sup>3</sup>	1.0 cm <sup>3</sup>
HQC8	3.0 cm <sup>3</sup>	3.0 cm <sup>3</sup>

## Materials of Construction

	STAINLESS STEEL PRODUCTS
MACHINED PARTS	Stainless Steel AISI type 316
SPRING AND RETAINING RINGS	Stainless Steel AISI type 316
SEALS	O-rings: Viton® is standard +20° F to +400° F

Standard seal lubrication is Krytox®.

- 1 Spider
- 2 Poppet
- 3 O-ring
- 4 Retaining ring
- 5 Locking tabs
- 6 Plug seal
- 7 Poppet guide
- 8 O-rings
- 9 Body
- 10 GYROLOK® front ferrule
- 11 GYROLOK® rear ferrule
- 12 GYROLOK® nut
- 13 Spring
- 14 O-ring
- 15 Poppet
- 16 Body housing
- 17 Body seat
- 18 Body sleeve
- 19 Plug sleeve
- 20 Spring
- 21 Plug

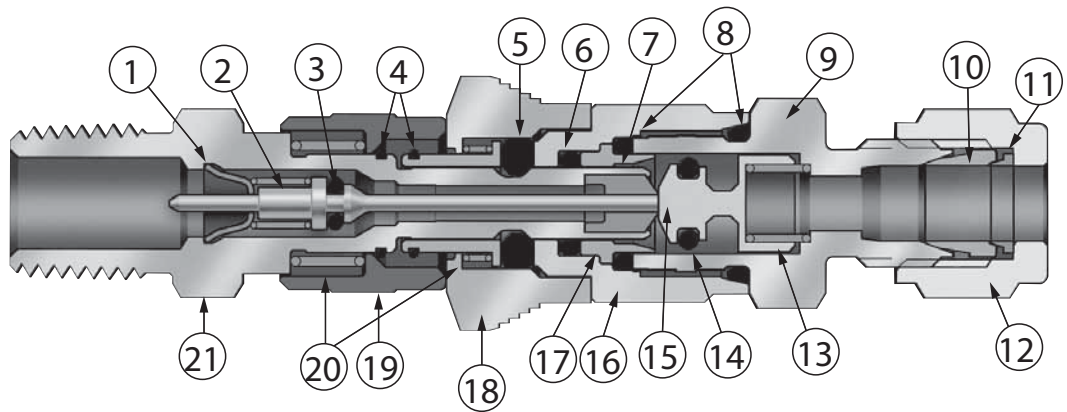

## Flow

### HQC4 SERIES

Max. Connect/Disconnect: 250 psig

Flow Rate of Water in GPM (68° F)

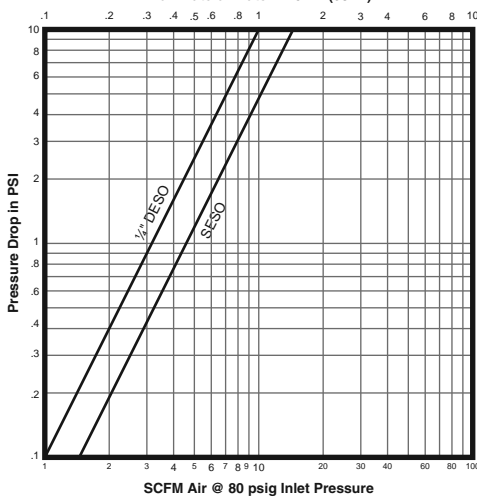

DESO C<sub>v</sub> = .31  
SESO C<sub>v</sub> = .45  
MAXIMUM FLOW RATE 4 GPM

### HQC6 SERIES

Max. Connect/Disconnect: 250 psig

Flow Rate of Water in GPM (68° F)

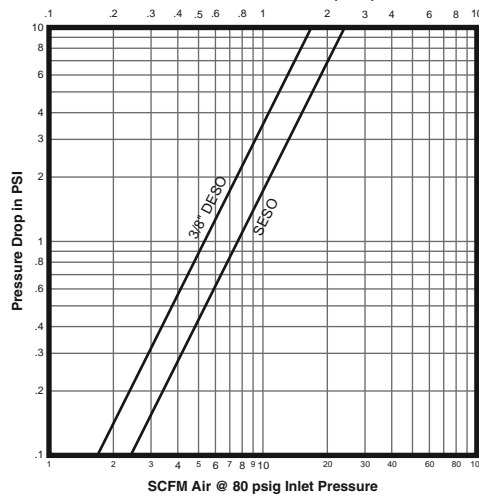

DESO C<sub>v</sub> = .53  
SESO C<sub>v</sub> = .74  
MAXIMUM FLOW RATE 6 GPM

### HQC8 SERIES

Max. Connect/Disconnect: 250 psig

Flow Rate of Water in GPM (68° F)

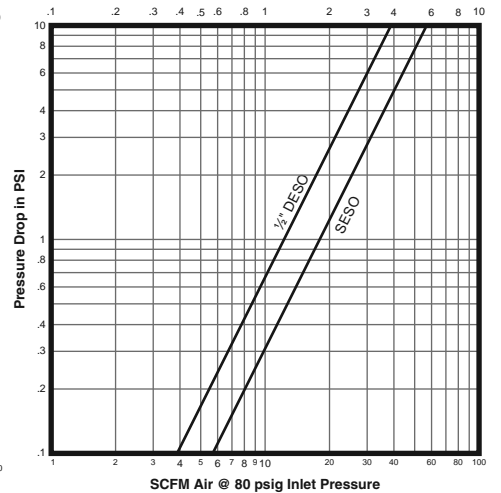

DESO C<sub>v</sub> = 1.26  
SESO C<sub>v</sub> = 1.86  
MAXIMUM FLOW RATE 10 GPM

# HQC Series Instrumentation Quick Couplings

## Dimensions: Body Assemblies with Valves

### Tube

SERIES	BODY SIZE	TUBE SIZE	PART NO.	A	B HEX	C
HQC4	¼	⅝	HQC4-B-2-316	2.18	0.63	0.88
HQC4	¼	¾	HQC4-B-4-316	2.22	0.63	0.88
HQC4	¼	6mm	HQC4-B-6MO-316	56.4mm	16.0mm	22.4mm
HQC6	⅜	⅝	HQC6-B-6-316	2.70	0.75	1.00
HQC6	⅜	10mm	HQC6-B-10MO-316	68.6mm	19.1mm	25.4mm
HQC8	½	½	HQC8-B-8-316	3.24	0.94	1.13
HQC8	½	12mm	HQC8-B-12MO-316	82.3mm	23.9mm	28.7mm

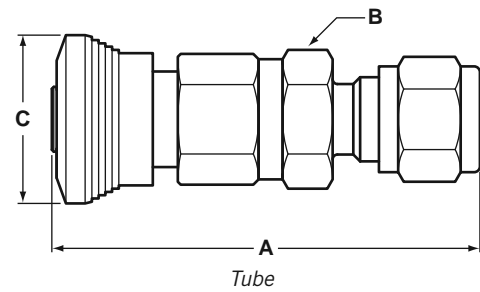

### Male Pipe

SERIES	BODY SIZE	PIPE THREAD	PART NO.	A	B HEX	C
HQC4	¼	⅝ NPT	HQC4-B-2M-316	1.83	0.63	0.88
HQC4	¼	¾ NPT	HQC4-B-4M-316	2.01	0.63	0.88
HQC4	¼	¾ BSPT	HQC4-B-4MT-316	2.01	0.63	0.88
HQC6	⅜	⅝ NPT	HQC6-B-4M-316	2.43	0.75	1.00
HQC6	⅜	⅝ NPT	HQC6-B-6M-316	2.43	0.75	1.00
HQC6	⅜	⅝ BSPT	HQC6-B-6MT-316	2.43	0.75	1.00
HQC8	½	½ NPT	HQC8-B-8M-316	2.83	0.94	1.13
HQC8	½	½ BSPT	HQC8-B-8MT-316	2.83	0.94	1.13

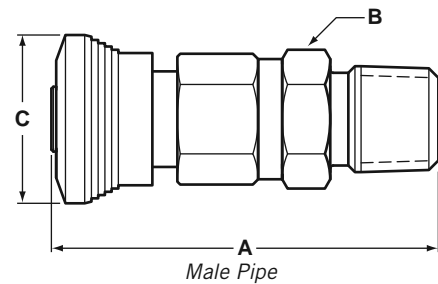

### Female Pipe

SERIES	BODY SIZE	PIPE THREAD	PART NO.	A	B HEX	C
HQC4	¼	⅝ NPT	HQC4-B-2F-316	2.10	0.63	0.88
HQC4	¼	¾ NPT	HQC4-B-4F-316	2.26	0.75	0.88
HQC4	¼	¾ BSPT	HQC4-B-4FT-316	2.26	0.75	0.88
HQC6	⅜	⅝ NPT	HQC6-B-4F-316	2.60	0.75	1.00
HQC6	⅜	⅝ NPT	HQC6-B-6F-316	2.63	0.88	1.00
HQC6	⅜	⅝ BSPT	HQC6-B-6FT-316	2.63	0.88	1.00
HQC8	½	½ NPT	HQC8-B-8F-316	3.25	1.06	1.13
HQC8	½	½ BSPT	HQC8-B-8FT-316	3.25	1.06	1.13

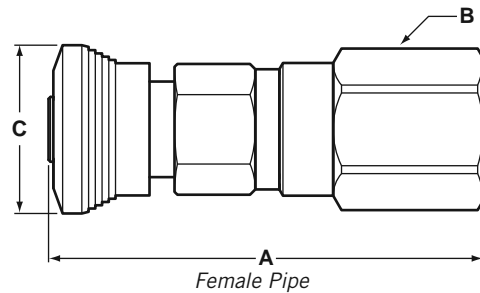

### Bulkhead Tube

SERIES	BODY SIZE	TUBE SIZE	PART NO.	A	B HEX	C
HQC4	¼	¾	HQC4-B1-4-316	2.59	0.63	0.88
HQC4	¼	6mm	HQC4-B1-6MO-316	65.8mm	16.0mm	22.4mm
HQC6	⅜	⅝	HQC6-B1-6-316	3.02	0.75	1.00
HQC6	⅜	10mm	HQC6-B1-10MO-316	76.7mm	19.1mm	25.4mm

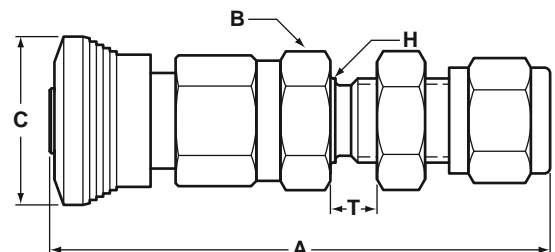

Bulkhead Tube

For 'H' and 'T' dimensions, see page 5

Note: All dimensions in inches unless specified as 'mm' (millimeters).

# HQC Series Instrumentation Quick Couplings

## Dimensions: Plugs, Non-valved, Single End Shutoff (SES0)

### Tube

SERIES	BODY SIZE	TUBE SIZE	PART NO.	A	B HEX	C
HQC4	¼	¼	HQC4-S-2-316	2.95	0.56	0.62
HQC4	¼	¼	HQC4-S-4-316	2.42	0.56	0.62
HQC4	¼	6mm	HQC4-S-6MO-316	79.2mm	14.2mm	15.7mm
HQC6	¾	¾	HQC6-S-6-316	2.60	0.69	0.74
HQC6	¾	10mm	HQC6-S-10MO-316	67.1mm	19.1mm	18.8mm
HQC8	½	½	HQC8-S-8-316	3.15	0.88	0.88
HQC8	½	12mm	HQC8-S-12MO-316	100.1mm	22.4mm	22.4mm

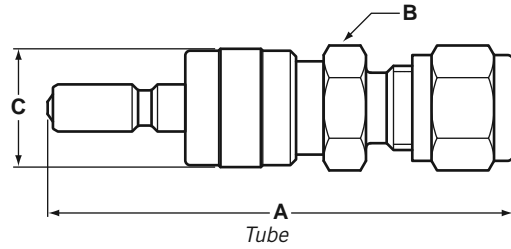

### Male Pipe

SERIES	BODY SIZE	PIPE THREAD	PART NO.	A	B HEX	C
HQC4	¼	¼ NPT	HQC4-S-2M-316	2.06	0.56	0.62
HQC4	¼	¼ NPT	HQC4-S-4M-316	2.24	0.56	0.62
HQC4	¼	¼ BSPT	HQC4-S-4MT-316	2.24	0.56	0.62
HQC6	¾	¼ NPT	HQC6-S-4M-316	2.33	0.75	0.74
HQC6	¾	¾ NPT	HQC6-S-6M-316	2.33	0.75	0.74
HQC6	¾	¾ BSPT	HQC6-S-6MT-316	2.33	0.75	0.74
HQC8	½	½ NPT	HQC8-S-8M-316	2.87	0.88	0.88
HQC8	½	½ BSPT	HQC8-S-8MT-316	2.87	0.88	0.88

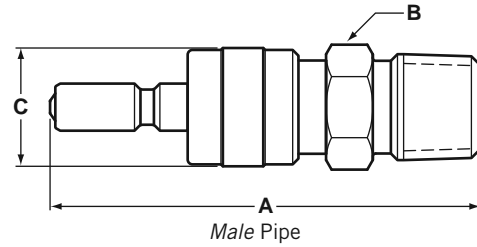

### Female Pipe

SERIES	BODY SIZE	PIPE THREAD	PART NO.	A	B HEX	C
HQC4	¼	¼ NPT	HQC4-S-2F-316	2.21	0.56	0.62
HQC4	¼	¼ NPT	HQC4-S-4F-316	2.34	0.75	0.62
HQC4	¼	¼ BSPT	HQC4-S-4FT-316	2.34	0.75	0.62
HQC6	¾	¼ NPT	HQC6-S-4F-316	2.51	0.75	0.74
HQC6	¾	¾ NPT	HQC6-S-6F-316	2.53	0.88	0.74
HQC6	¾	¾ BSPT	HQC6-S-6FT-316	2.53	0.88	0.74
HQC8	½	½ NPT	HQC8-S-8F-316	3.12	1.06	0.88
HQC8	½	½ BSPT	HQC8-S-8FT-316	3.12	1.06	0.88

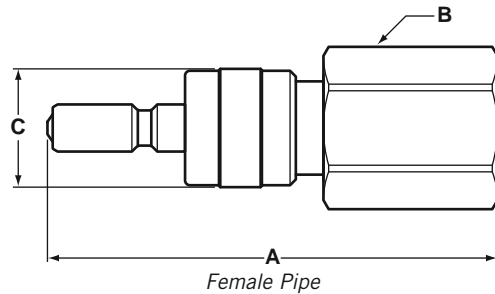

### Bulkhead Tube

SERIES	BODY SIZE	TUBE SIZE	PART NO.	A	B HEX	C
HQC4	¼	¼	HQC4-S1-4-316	2.80	0.56	0.62
HQC4	¼	6mm	HQC4-S1-6MO-316	88.8mm	14.2mm	15.7mm
HQC6	¾	¾	HQC6-S1-6-316	3.24	0.69	0.74
HQC6	¾	10mm	HQC6-S1-10MO-316	82.3mm	19.1mm	18.8mm

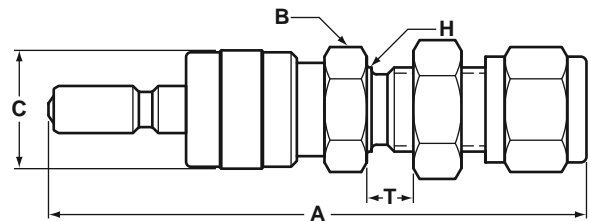

Bulkhead Tube  
For 'H' and 'T' dimensions, see page 5

### Hose Barb

SERIES	BODY SIZE	HOSE	PART NO.	A	B HEX	C
HQC6	¾	¾	HQC6-S-6H-316	2.66	0.69	0.74

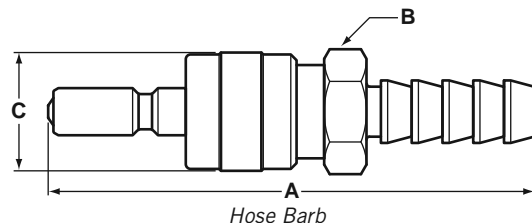

Note: All dimensions in inches unless specified as 'mm' (millimeters).

# HQC Series Instrumentation Quick Couplings

## Dimensions: Plugs, Valved, Double End Shutoff (DESO)

### Tube

SERIES	BODY SIZE	TUBE SIZE	PART NO.	A	B HEX	C
HQC4	¼	½	HQC4-D-2-316	2.95	0.56	0.62
HQC4	¼	¼	HQC4-D-4-316	2.42	0.56	0.62
HQC4	¼	6mm	HQC4-D-6MO-316	79.2mm	14.2mm	15.7mm
HQC6	¾	¾	HQC6-D-6-316	2.60	0.69	0.74
HQC6	¾	10mm	HQC6-D-10MO-316	67.1mm	19.1mm	18.8mm
HQC8	½	½	HQC8-D-8-316	3.15	0.88	0.88
HQC8	½	12mm	HQC8-D-12MO-316	100.1mm	22.4mm	22.4mm

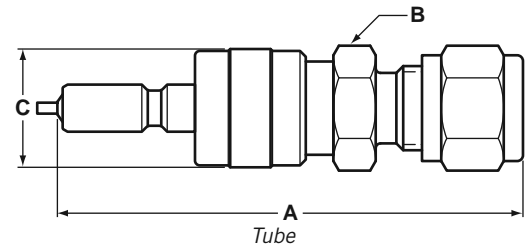

### Male Pipe

SERIES	BODY SIZE	PIPE THREAD	PART NO.	A	B HEX	C
HQC4	¼	½ NPT	HQC4-D-2M-316	2.06	0.56	0.62
HQC4	¼	¼ NPT	HQC4-D-4M-316	2.24	0.56	0.62
HQC4	¼	¼ BSPT	HQC4-D-4MT-316	2.24	0.56	0.62
HQC6	¾	¼ NPT	HQC6-D-4M-316	2.34	0.75	0.74
HQC6	¾	¾ NPT	HQC6-D-6M-316	2.34	0.75	0.74
HQC6	¾	¾ BSPT	HQC6-D-6MT-316	2.34	0.75	0.74
HQC8	½	½ NPT	HQC8-D-8M-316	2.87	0.88	0.88
HQC8	½	½ BSPT	HQC8-D-8MT-316	2.87	0.88	0.88

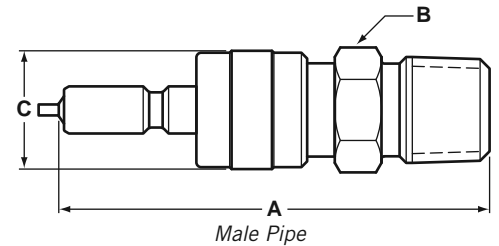

### Female Pipe

SERIES	BODY SIZE	PIPE THREAD	PART NO.	A	B HEX	C
HQC4	¼	½ NPT	HQC4-D-2F-316	2.21	0.56	0.62
HQC4	¼	¼ NPT	HQC4-D-4F-316	2.34	0.75	0.62
HQC4	¼	¼ BSPT	HQC4-D-4FT-316	2.34	0.75	0.62
HQC6	¾	¼ NPT	HQC6-D-4F-316	2.51	0.75	0.74
HQC6	¾	¾ NPT	HQC6-D-6F-316	2.53	0.88	0.74
HQC6	¾	¾ BSPT	HQC6-D-6FT-316	2.53	0.88	0.74
HQC8	½	½ NPT	HQC8-D-8F-316	3.12	1.06	0.88
HQC8	½	½ BSPT	HQC8-D-8FT-316	3.12	1.06	0.88

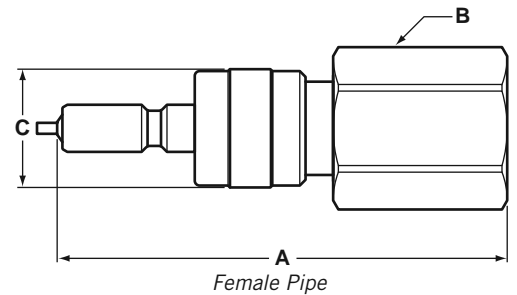

### Bulkhead Tube

SERIES	BODY SIZE	TUBE SIZE	PART NO.	A	B HEX	C
HQC4	¼	¼	HQC4-D1-4-316	2.80	0.56	0.62
HQC4	¼	6mm	HQC4-D1-6MO-316	88.8mm	14.2mm	15.7mm
HQC6	¾	¾	HQC6-D1-6-316	3.24	0.69	0.74
HQC6	¾	10mm	HQC6-D1-10MO-316	82.3mm	19.1mm	18.8mm

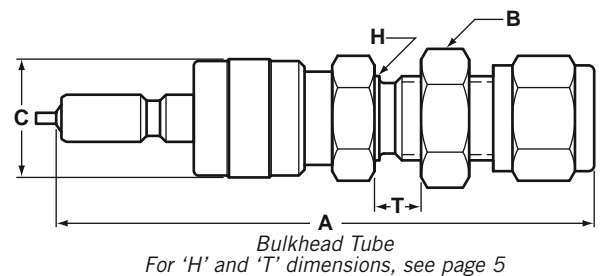

Bulkhead Tube  
For 'H' and 'T' dimensions, see page 5

Note: All dimensions in inches unless specified as 'mm' (millimeters).

# HQC Series Instrumentation Quick Couplings

## HOKE Color-Coded Keyed Quick Couplers

HOKE® keyed quick couplers will fit only mating keyed components, preventing accidental mixing of fluid or pressure lines.

Body and plug assemblies are numbered and color-coded for positive identification.

HOKE® keyed HQC Series quick couplers are interchangeable with Swagelok® and Parker® components of the same style. For example, the HOKE® K1 body sleeve will fit a Swagelok® K1 plug sleeve of the same size.



KEY NUMBER	COLOR	HQC4		HQC6		HQC8	
		BODY SLEEVE O.D.	PLUG SLEEVE O.D.	BODY SLEEVE O.D.	PLUG SLEEVE O.D.	BODY SLEEVE O.D.	PLUG SLEEVE O.D.
K1	Black	0.96	0.82	1.13	0.99	1.26	1.10
K2	Orange	0.99	0.85	1.16	1.02	1.29	1.14
K3	Green	1.02	0.88	1.19	1.05	1.32	1.17
K4	Yellow	1.05	0.91	1.22	1.08	1.35	1.20
K5	Blue	1.08	0.94	1.24	1.11	1.38	1.23
K6	White	1.11	0.97	1.28	1.14	1.41	1.26
K7	Purple	1.14	1.00	1.31	1.17	1.44	1.29
K8	Brown	1.17	1.03	1.34	1.20	1.47	1.32

Keys K1–K5 are standard stock items. For keys K6–K8, consult the factory.

## Panel Mount Dimensions

from Bulkhead drawings on pages 2, 3, and 4

	BULKHEAD SIZE	H	T
		PANEL HOLE	PANEL THICKNESS
HQC4	½" GYROLOK®	0.328"	0.250" max.
	¼" GYROLOK®	0.469"	0.250" max.
	6mm GYROLOK®	11.9mm	6.3mm max.
HQC6	¼" GYROLOK®	0.469"	0.250" max.
	⅜" GYROLOK®	0.594"	2.70" max.
	10mm GYROLOK®	15.1mm	6.9mm max.
HQC8	½" GYROLOK®	0.781"	0.260" max.



# HQC Series Instrumentation Quick Couplings

## How to Order

Standard items in bold.

**HQC4 – B1 – 4 F – K1 – 316 – 203**

**BODY SIZE**

**HQC4** ¼"  
**HQC6** ⅜"  
**HQC8** ½"

**COMPONENT**

**B** Body  
**B1** Bulkhead body  
**D** Plug valved  
**D1** Plug valved bulkhead  
**S** Plug non-valved  
**S1** Plug non-valved bulkhead

**PORT SIZE**

<b>2</b> ⅛"	<b>6MO</b> 6mm
<b>4</b> ¼"	<b>8MO</b> 8mm
<b>6</b> ⅜"	<b>10MO</b> 10mm
<b>8</b> ½"	<b>12MO</b> 12mm

**SEAL OPTIONS**

**Blank** Standard seal (Viton®)  
**203** Kalrez®  
**204** Ethylene Propylene  
**205** Buna N  
**206** Neoprene

**MATERIALS**

**316** Stainless steel

**OPTIONS**

**Blank** No options  
**C** Oxygen clean  
**K1-K8** Keyed sleeves (see page 6)

**PORT CONFIGURATIONS**

**Blank** Tube fitting  
**F** Female NPT  
**FT** Female British taper pipe  
**H** Hose barb  
**M** Male NPT  
**MT** Male British taper pipe

*Standard seal lubricant is Krytox®.*

## Accessories

### Dust Caps

SERIES	BODY SIZE	PART NO.	A	B HEX	C
HQC4	¼"	<b>HQC4-C-316</b>	1.45	0.63	0.88
HQC6	⅜"	<b>HQC6-C-316</b>	1.45	0.75	1.00
HQC8	½"	<b>HQC8-C-316</b>	1.65	0.94	1.13

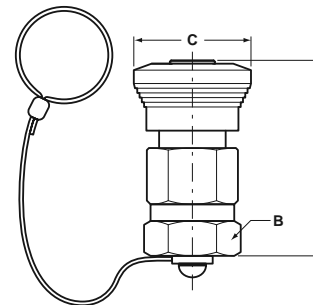

### Dust Plugs

SERIES	BODY SIZE	PART NO.	A	B HEX	C
HQC4	¼"	<b>HQC4-P-316</b>	1.88	0.57	0.62
HQC6	⅜"	<b>HQC6-P-316</b>	1.98	0.63	0.74
HQC8	½"	<b>HQC8-P-316</b>	2.25	0.75	0.88

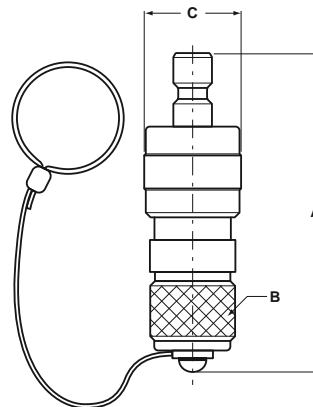

Xylan® is a registered trademark of Whitford Corporation.  
 GYROLOK® is a registered trademark of HOKE®.  
 Kalrez® and Viton® are registered trademarks of DuPont Dow Elastomers.  
 Krytox® is a registered trademark of the DuPont Company.  
 Swagelok® is a registered trademark of Swagelok Company.  
 Parker® is a registered trademark of Parker Hannifin Corporation

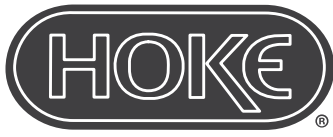

---

## The Small Bore Instrumentation Specialists

---

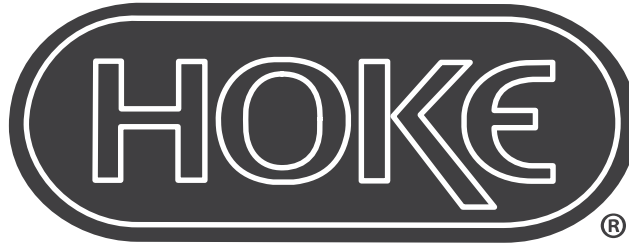

We specialize in small bore instrumentation products up to 2" that deliver benchmark performance quality & safety; provide the broadest array of superior alloy offerings in the market; decades of proven success in a wide range of industries; a roster of "who's who" customers & projects globally; original "Best Solution" engineering & designs; and are focused on continuous improvement in all aspects of our business.

### Proudly Distributed By:



Authorized distributor in Iraq:  
DHIAA AL-AMEEN CO., LTD. FOR GENERAL CONTRACTING LTD  
Al-Saadi Street - opposite the Central Library  
Basra-Iraq  
supply department:  
supply@dhialameen.com  
+9647853807448  
www.dhialameen.com

CRANE INSTRUMENTATION &  
SAMPLING Inc.  
405 Centura Ct.  
Spartanburg, SC 29305, USA  
Tel: 1-864-574-7966  
PO Box 4866, Spartanburg, SC  
29305-4866 USA

Crane Co., and its subsidiaries cannot accept responsibility for possible errors in catalogues, brochures, other printed materials, and website information. Crane Co. reserves the right to alter its products without notice, including products already on order provided that such alteration can be made without changes being necessary in specifications already agreed. All trademarks in this material are the property of the Crane Co. or its subsidiaries. The Crane and Crane brands logotype (CENTER LINE®, COMPAC-NOZ®, CRANE®, DEPA® & ELRO®, DOPAK®, DUO-CHEK®, FLOWSEAL®, GYROLOK®, GO REGULATOR®, HOKE®, JENKINS®, KROMBACH®, NOZ-CHEK®, PACIFIC VALVES®, RESISTOFLEX®, REVO®, SAUNDERS®, STOCKHAM®, TEXAS SAMPLING®, TRIANGLE®, UNI-CHEK®, VALVES®, WTA®, and XOMOX®) are registered trademarks of Crane Co. All rights reserved.